

H.W. #17 EE 221 Spring 2023

Show your work for credit and put a box around each of your answers (follow the hw guidelines!)

1. Using the Laplace transform solve for the current flowing in the following circuit. Verify your answer using LTspice. (5 points)

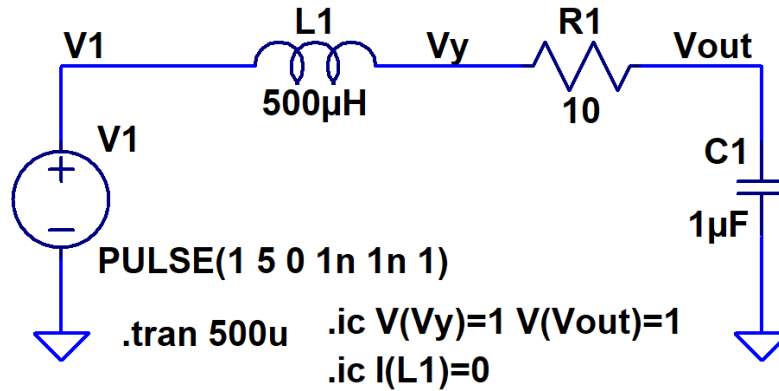

2. Repeat problem 1 (find the current) for the following circuit. (5 points)

