

Midterm Exam – EE 220 Circuits I
Fall 2023 – University of Nevada, Las Vegas

NAME: _____

Closed book and notes.

Show your work for credit and put a box around your answers.

1. Find the current, in the following circuit, that flows in R2. (10 points)

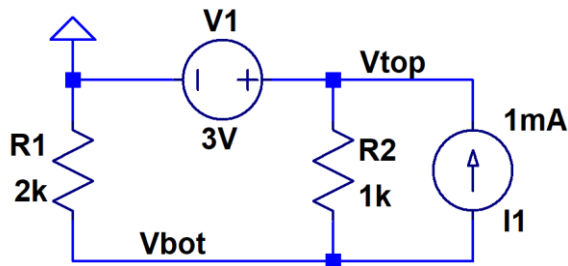

2. Find V_x in the following circuit **using superposition**. (10 points)

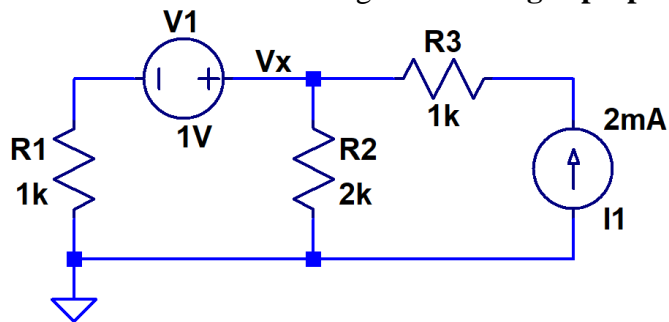

3. Find the voltage V_x in the circuit seen below. Then find the Thevenin equivalent circuit, with R_2 removed, at the terminals marked by dots. Show that your Thevenin circuit is correct by comparing the value you calculated for V_x to the one you get when you put R_2 across the terminals of your Thevenin equivalent. (20 points)

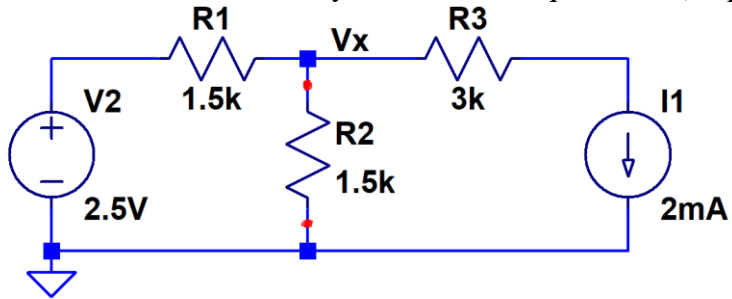

4. Using mesh analysis find the voltage V_x in the following circuit. (20 points)

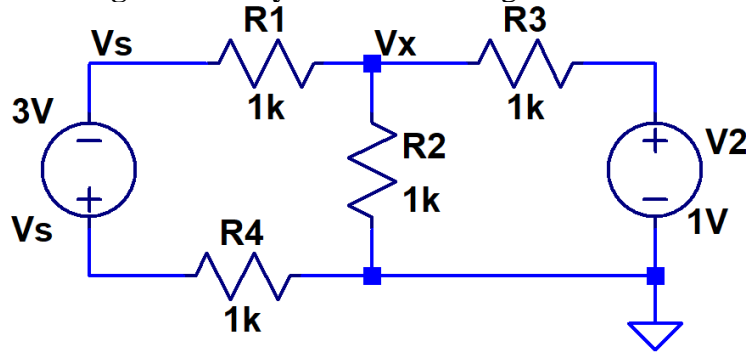

5. Find V_{out} in the following circuit. (20 points)

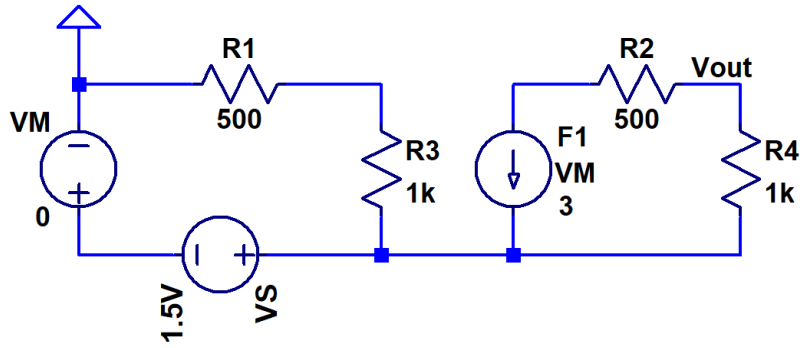

6. Find V_B in the following circuit. (20 points)

