

H.W. #8 EE 220 Fall 2020

Show your work for credit!

- Find the voltages in the following circuits using any method you would like. Verify your hand calculations using LTSpice. (4 points)

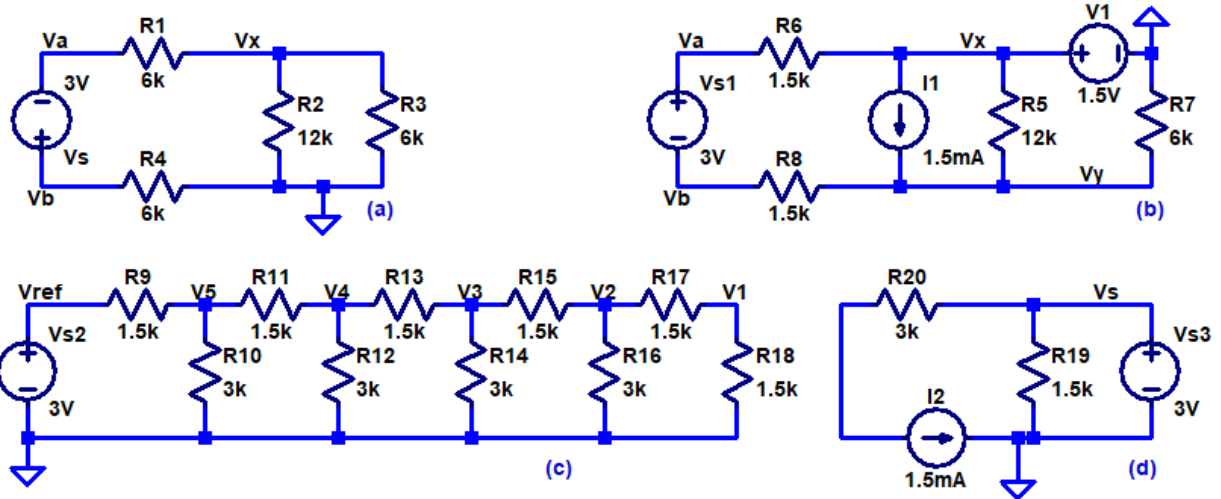

- Determine the currents and voltages in the following circuits using both superposition and mesh analysis. Verify your hand calculations using LTSpice. (6 points)

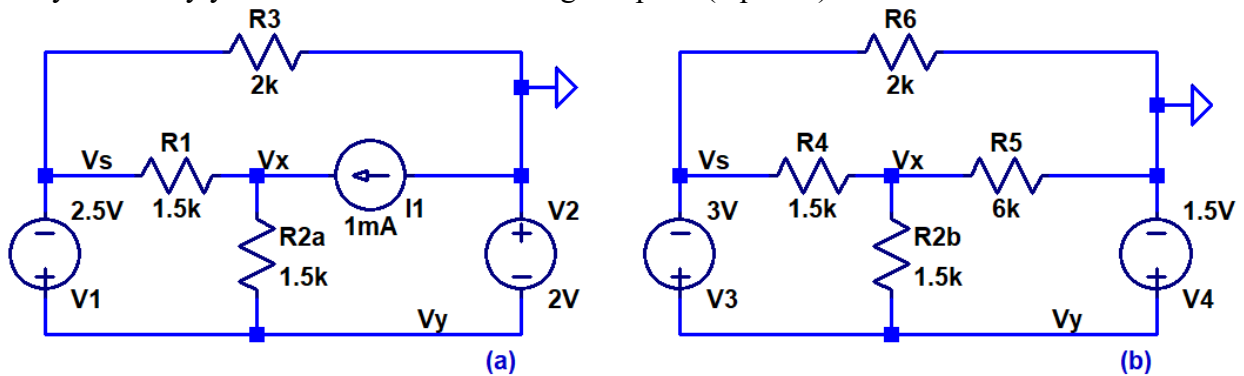

- For the circuits in problem 2 find the Thevenin and Norton equivalent circuits from V_x to ground (with R_2 in the circuit). Show that you get the same value for V_x that you calculated in problem 2 with your equivalent circuits for both Thevenin and Norton equivalent circuits. Verify your Thevenin and Norton circuits are correct using LTSpice. (4 points)