

H.W. #7 EE 220 Fall 2020

Show your work for credit!

- Find the Thevenin and Norton equivalent circuits between V_x and ground with R_2 removed. Show that when you connect R_2 to the Thevenin and Norton equivalents that you get the same value for V_x . Verify your hand calculations using LTspice. Note that you can also Thevenize the circuits between V_x and ground with R_2 present. (8 points)

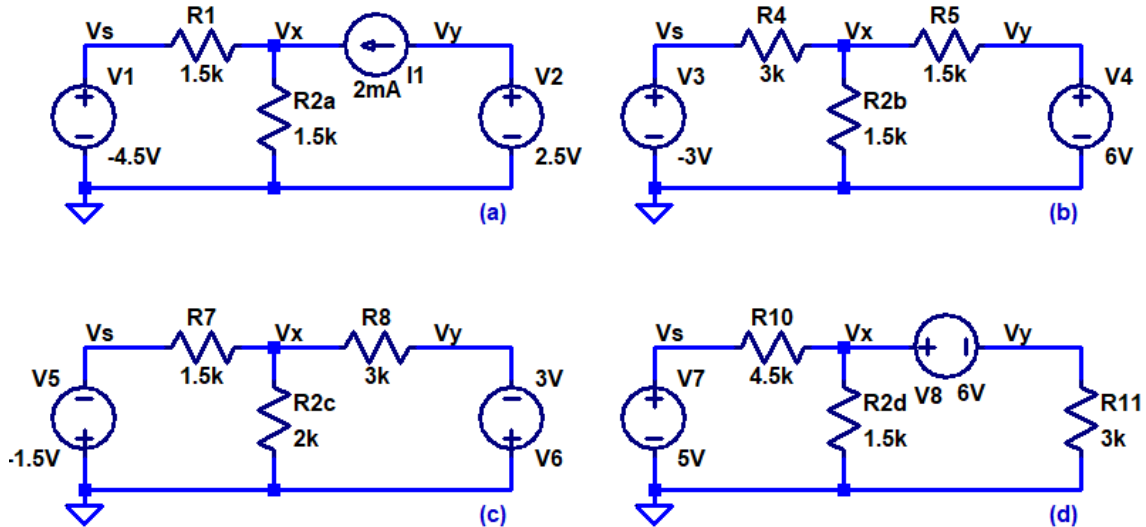

- Determine the currents and voltages in the following circuits using mesh analysis. Verify your hand calculations using LTspice. (4 points)

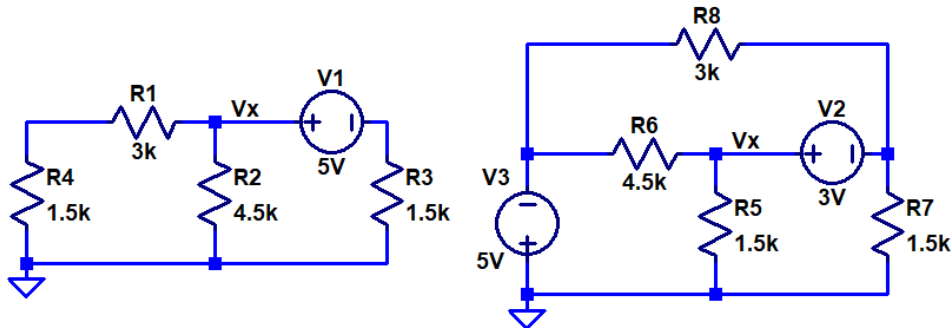

- Find all voltages in the following circuit. Verify your hand calculations using LTspice. As always, show your work for credit. (2 points)

