

H.W. #8 EE 220 Fall 2017

Show your work for credit!

- Find the voltages in the following circuits using any method you would like. Verify your hand calculations using LTspice. (4 points)

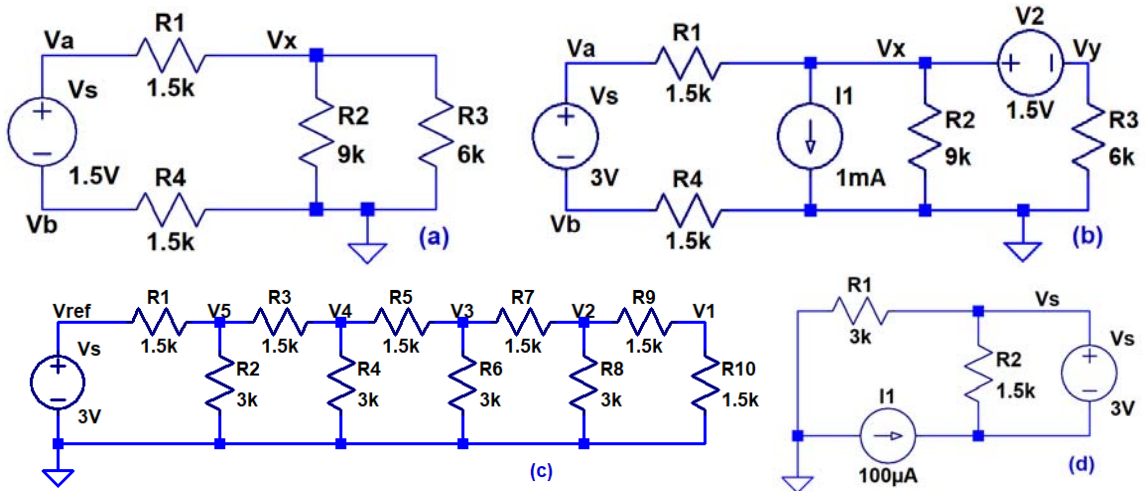

- Determine the currents and voltages in the following circuits using both superposition and mesh analysis. Verify your hand calculations using LTspice. (6 points)

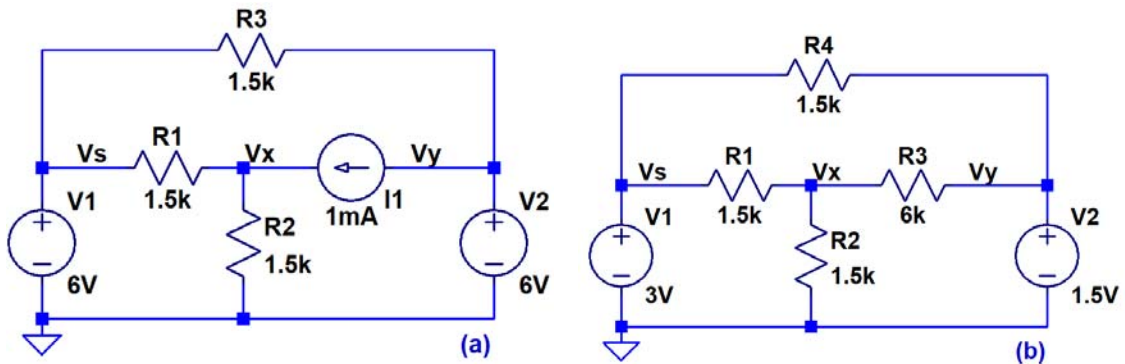

- For the circuits in problem 2 find the Thevenin and Norton equivalent circuits from  $V_x$  to ground without  $R_2$  in the circuit. Show, with  $R_2$  back in the circuit, that you get the same value for  $V_x$  that you calculated in problem 2. Verify your Thevenin and Norton circuits are correct using LTspice. (4 points)