

Lecture 26 12/6/11

Charge pumps

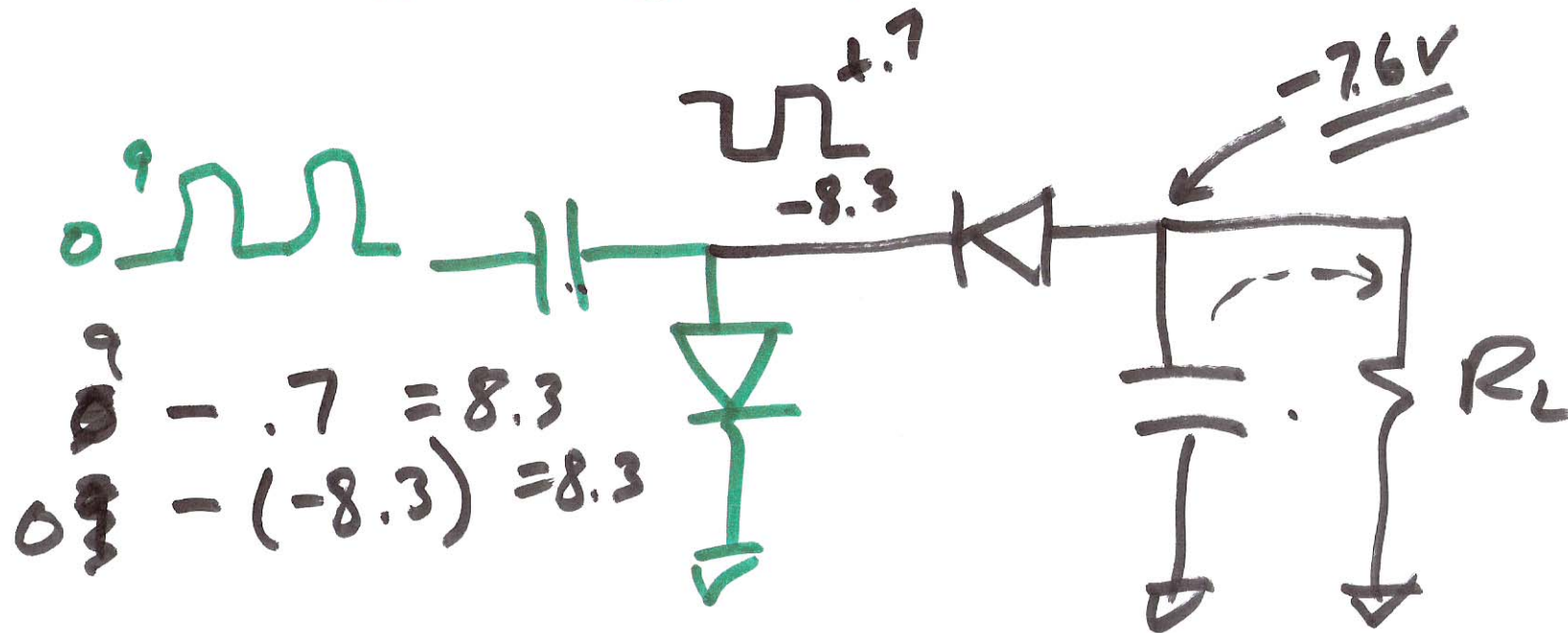

11

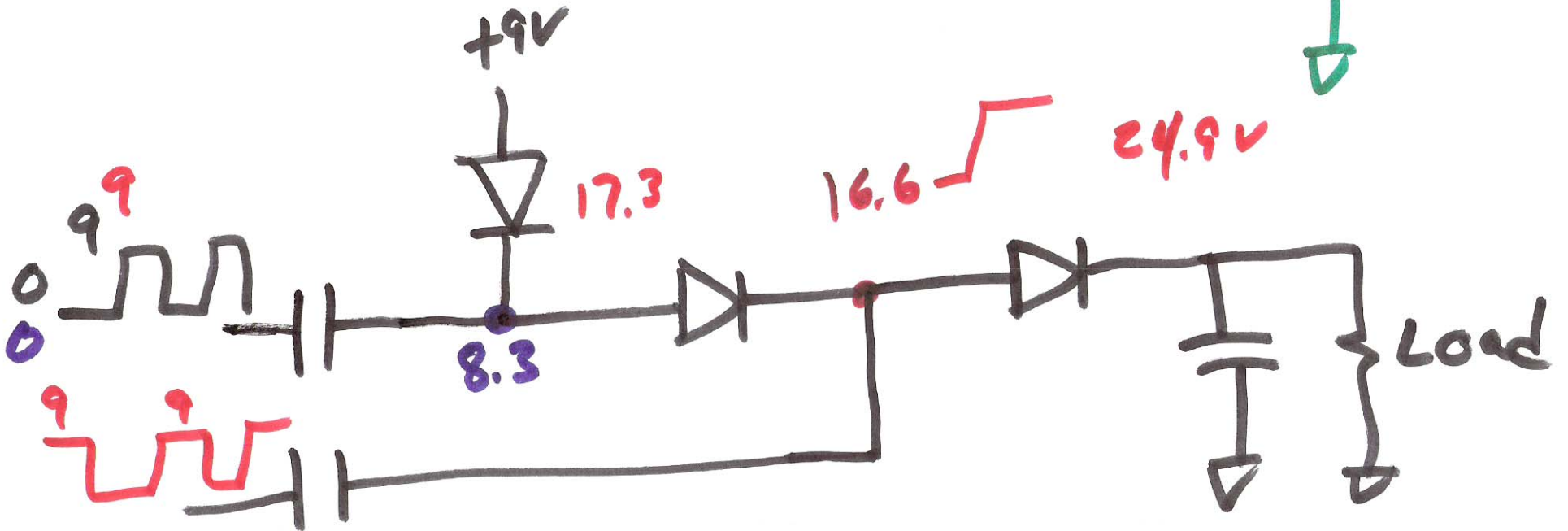
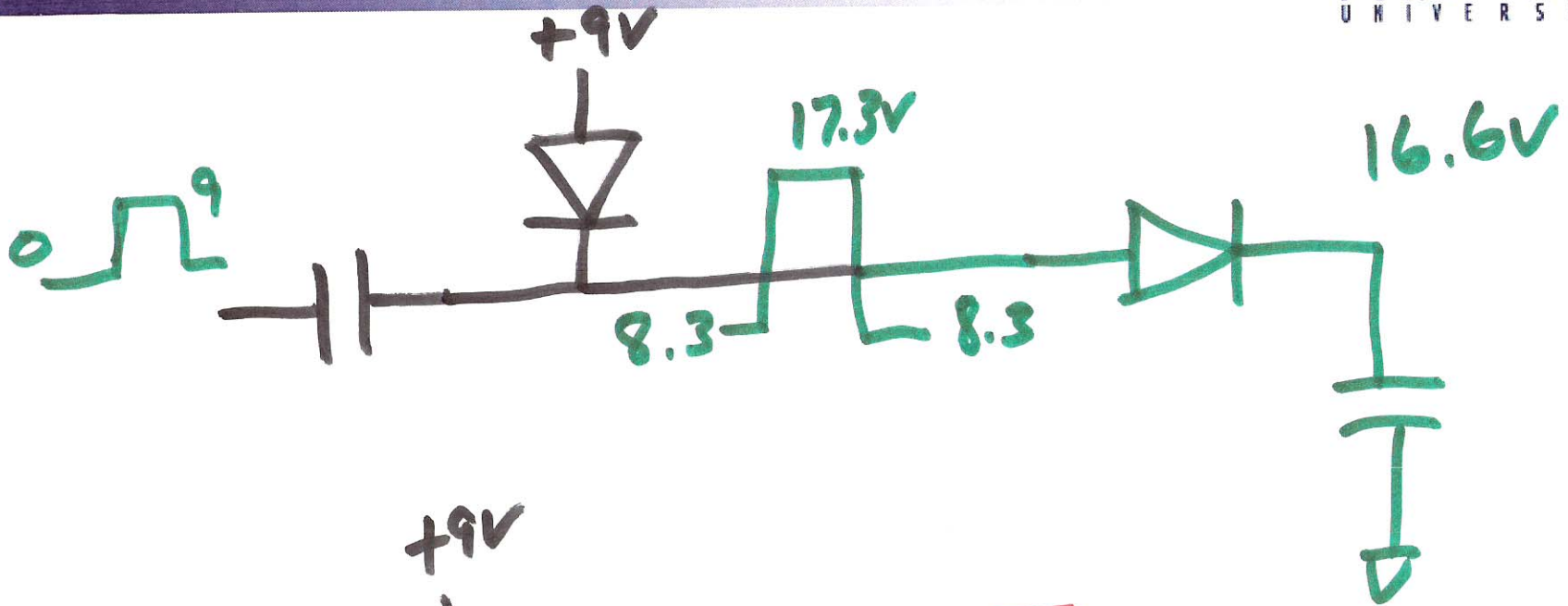

2)

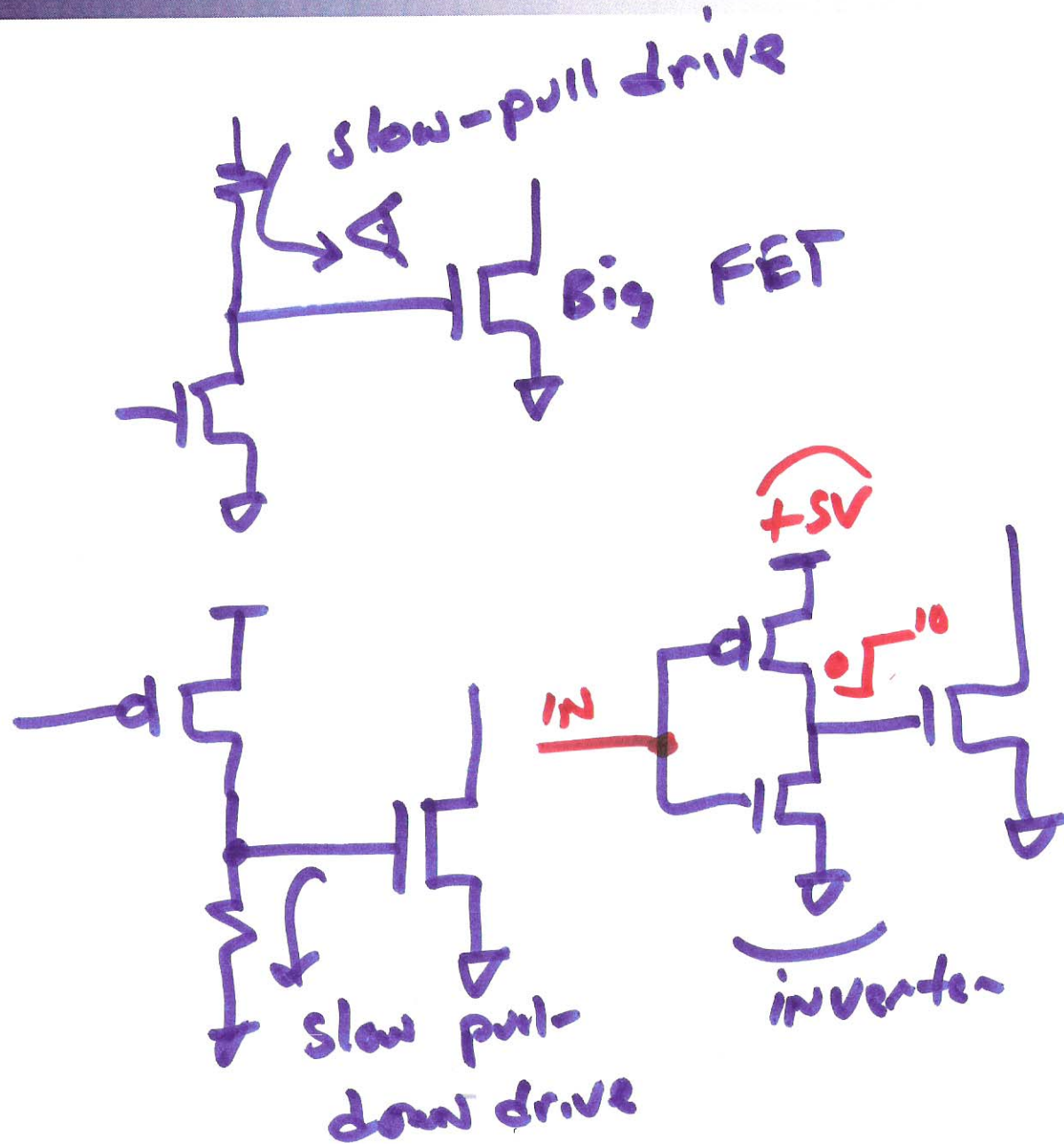

3)

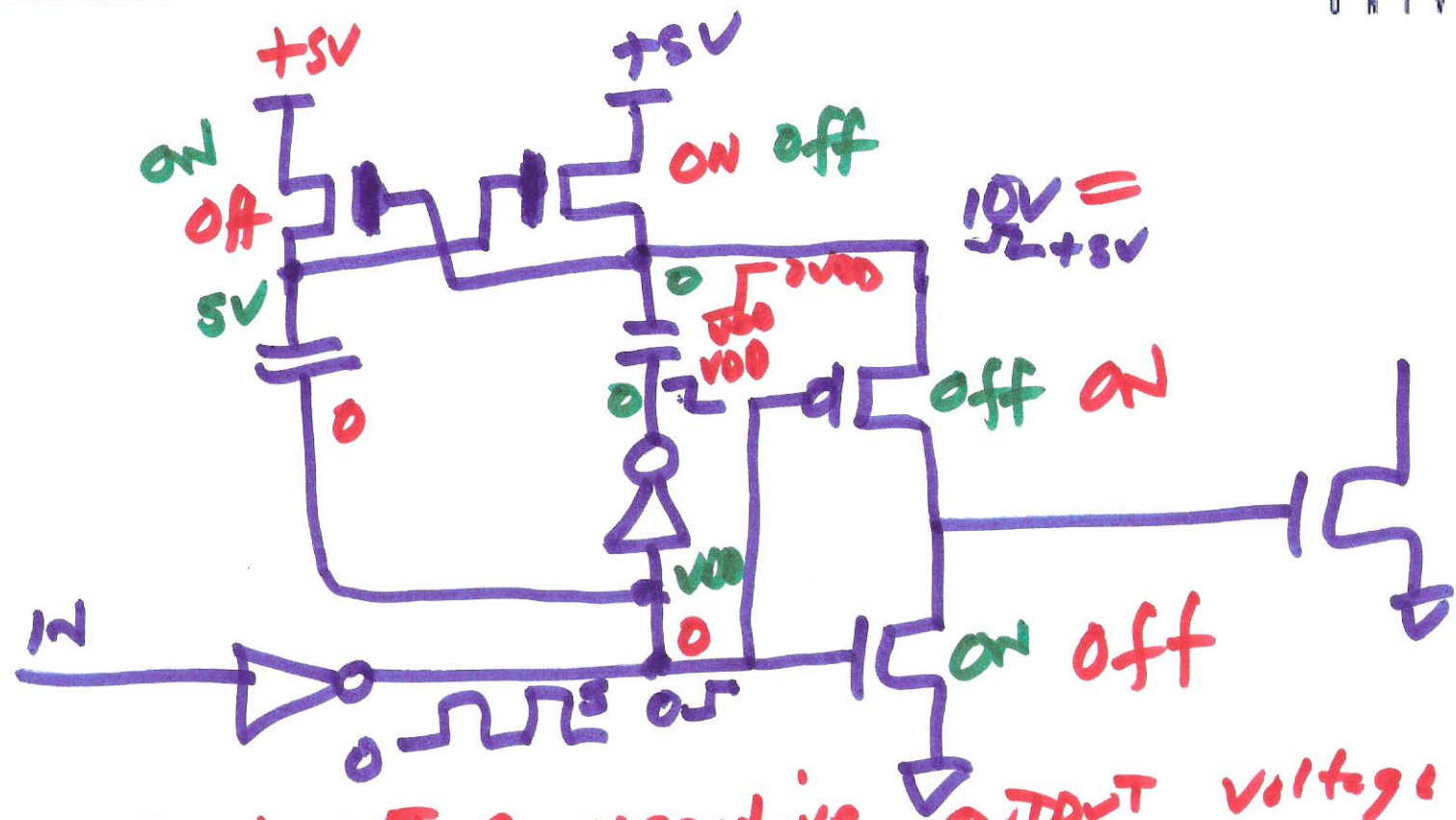

Implement a negative output voltage charge pump using NMOS devices

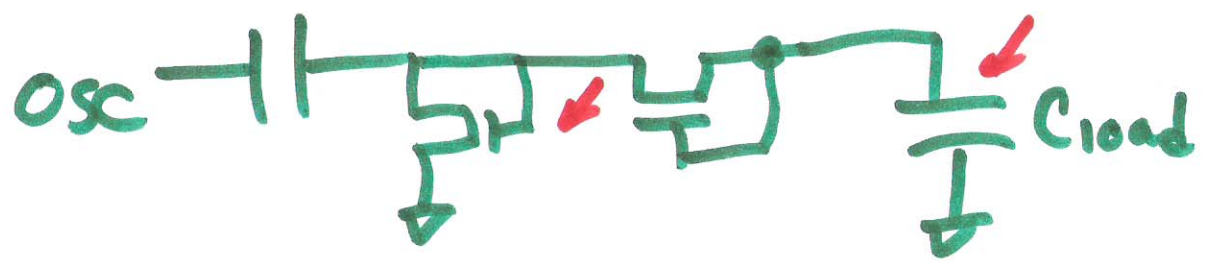

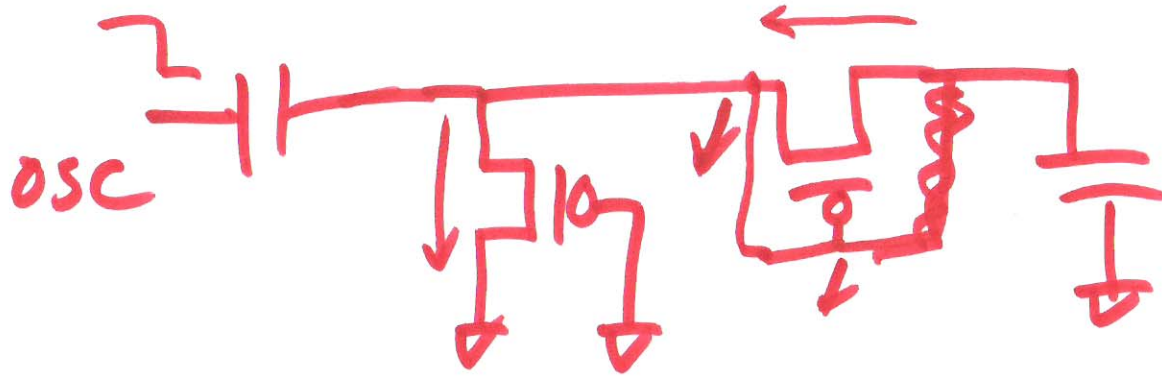

5)